

ULINE H-1383

1-800-295-5510
 uline.com

**STAIR CLIMBER FOR
 STANDARD MAGLINER
 ALUMINUM HAND TRUCKS**

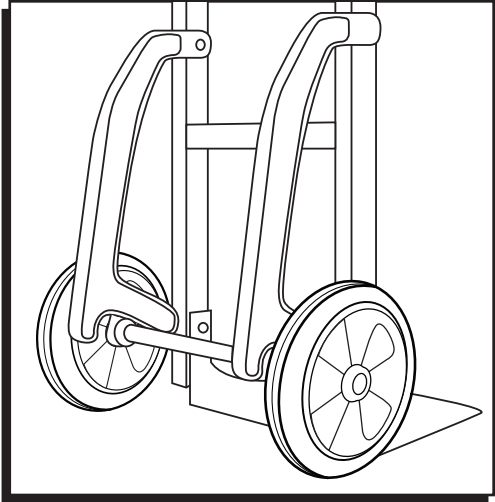

TOOLS NEEDED

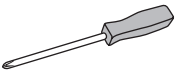

#3 Phillips
 Screwdriver

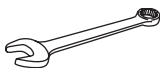

1/2" Combination or
 Socket Wrench

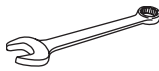

7/16" Combination or
 Socket Wrench

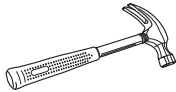

Hammer

PARTS

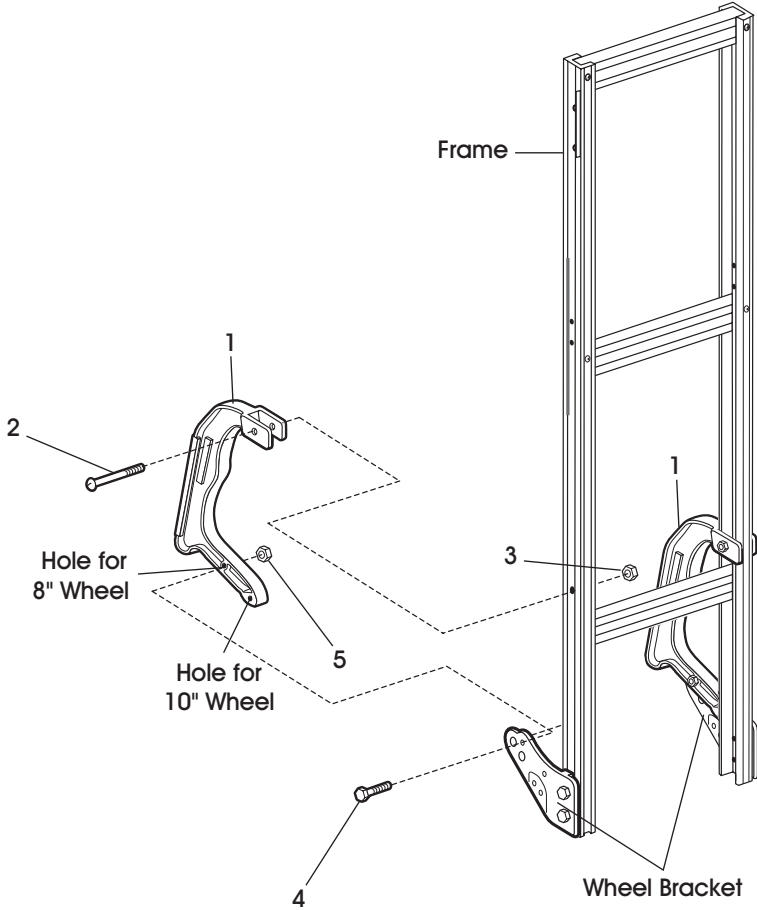

#	QTY	DESCRIPTION
1	2	Stair Climber
2	2	1/4"-20 x 1 7/8" - Pan Head Bolt
3	2	1/4" - Locknut
4	2	5/16"-18 x 1 1/4" - Hex Head Bolt
5	2	5/16" - Locknut

ASSEMBLY

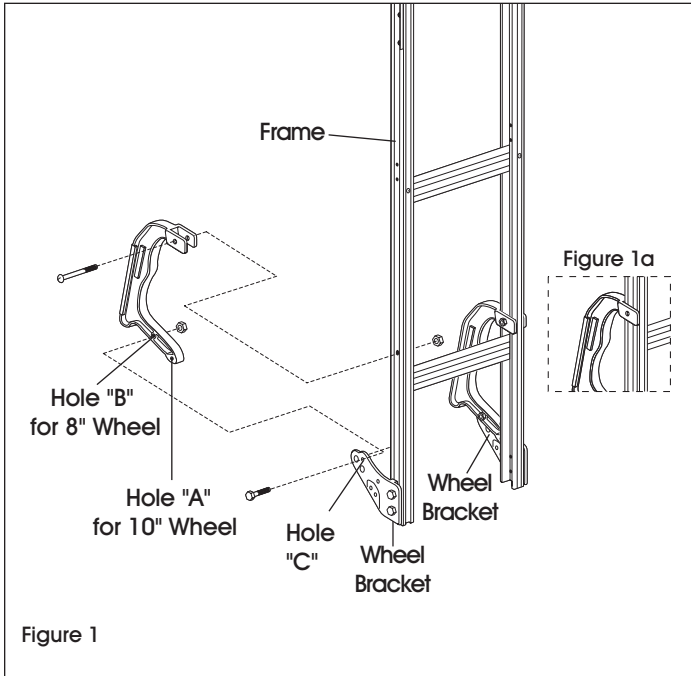

1. Assemble stair climber on each side. (See Figure 1)
 - a. Align hole of stair climber (hole marked "A" for 10" wheels or "B" for 8" wheels) with top hole "C" in wheel bracket.
 - b. Insert one 5/6"-18 x 1 1/4" hex head bolt through the outside of the wheel bracket and stair climber. Secure with one 5/16" locknut but DO NOT tighten.
 - c. Push stair climber towards hand truck frame until the open end of the stair climber fits over the frame. (See Figure 1a)
 - d. Insert one 1/4"-20 x 1 7/8" pan head bolt through the side of the stair climber and frame. Use a hammer to pierce 1/4"-20 x 1 7/8" pan head bolt through the frame. Secure with one 1/4" locknut.
 - e. Tighten all locknuts.

ULINE H-1383

01-800-295-5510

uline.mx

ADITAMENTO DE ESCALERA PARA DIABLITOS DE ALUMINIO MAGLINER ESTÁNDAR

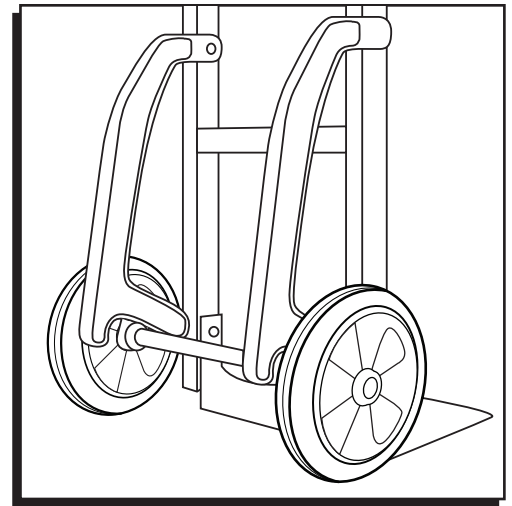

HERRAMIENTAS NECESARIAS

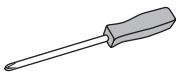

Desarmador Phillips #3

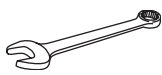

Llave Combinada o de Dado de 1/2"

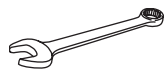

Llave Combinada o de Dado de 7/16"

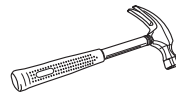

Martillo

PARTES

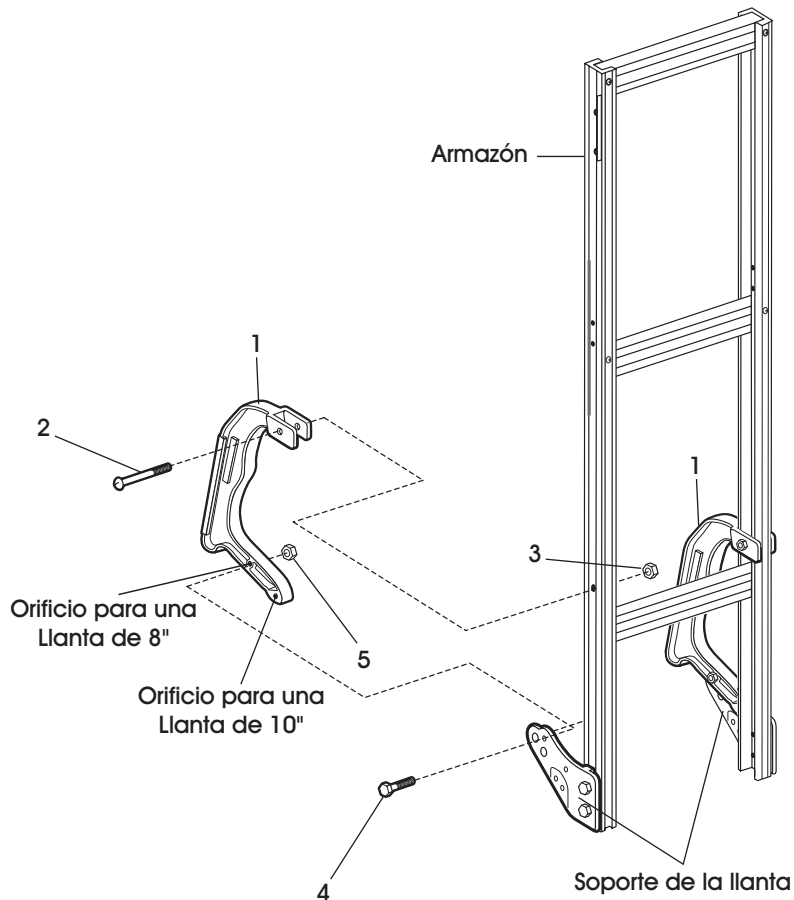

#	CANT.	DESCRIPCIÓN
1	2	Aditamento de Escaleras
2	2	Perno de Cabeza Alomada de 1/4"-20 x 1 7/8"
3	2	Tuerca de Seguridad de 1/4"
4	2	Perno de Cabeza Hexagonal de 5/16"-18 x 1 1/4"
5	2	Tuerca de Seguridad de 5/16"

ENSAMBLE

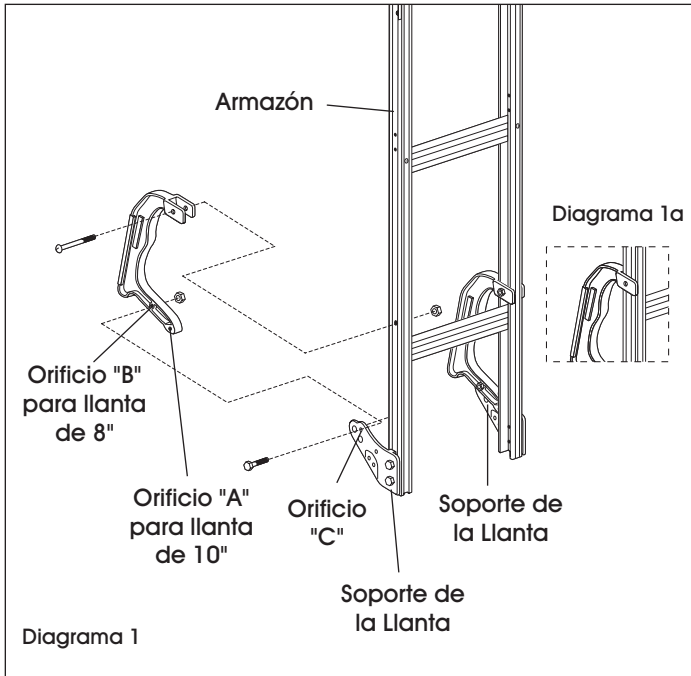

1. Ensamble el aditamento a cada lado.
(Vea Diagrama 1)
 - a. Alinee el orificio del aditamento. (Orificio marcado como "A" para las llantas de 10" o "B" para las llantas de 8", con el orificio superior "C" en el soporte de la llanta).
 - b. Inserte un perno de cabeza hexagonal de 5/6"-18 x 1¼" a través del exterior del soporte de la llanta y el aditamento. Asegure con una tuerca de seguridad de 5/16" pero NO apriete.
 - c. Empuje el aditamento hacia el marco del diablito hasta que el extremo quepa por encima del marco. (Vea Diagrama 1a)
 - d. Inserte un perno de cabeza alomada de 1/4"-20 x 1⅞" a través del lado del aditamento y el marco. Use un martillo para insertar un perno de cabeza alomada de 1/4"-20 x 1⅞" en el marco. Asegure con una tuerca de seguridad de 1/4".
 - e. Apriete todas las tuercas de seguridad.

ULINE H-1383

MAGLINER - ESCALADEUR STANDARD POUR DIABLES DE MANUTENTION EN ALUMINIUM

1-800-295-5510

uline.ca

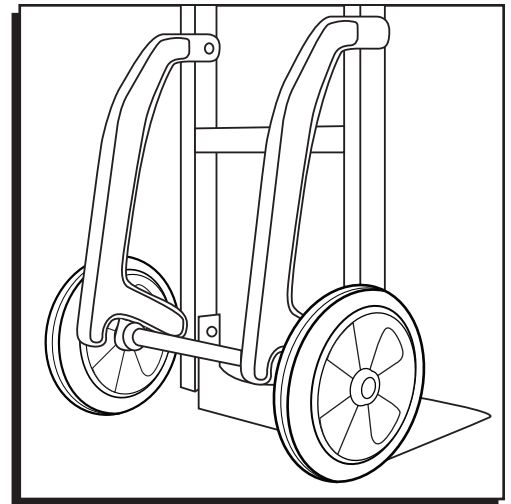

OUTILS REQUIS

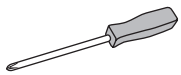

Tournevis
cruciforme n° 3

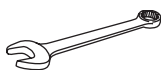

Clé mixte ou à
douilles de 1/2 po

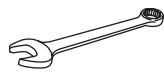

Clé mixte ou à
douilles de 7/16 po

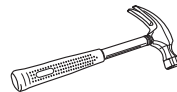

Marteau

PIÈCES

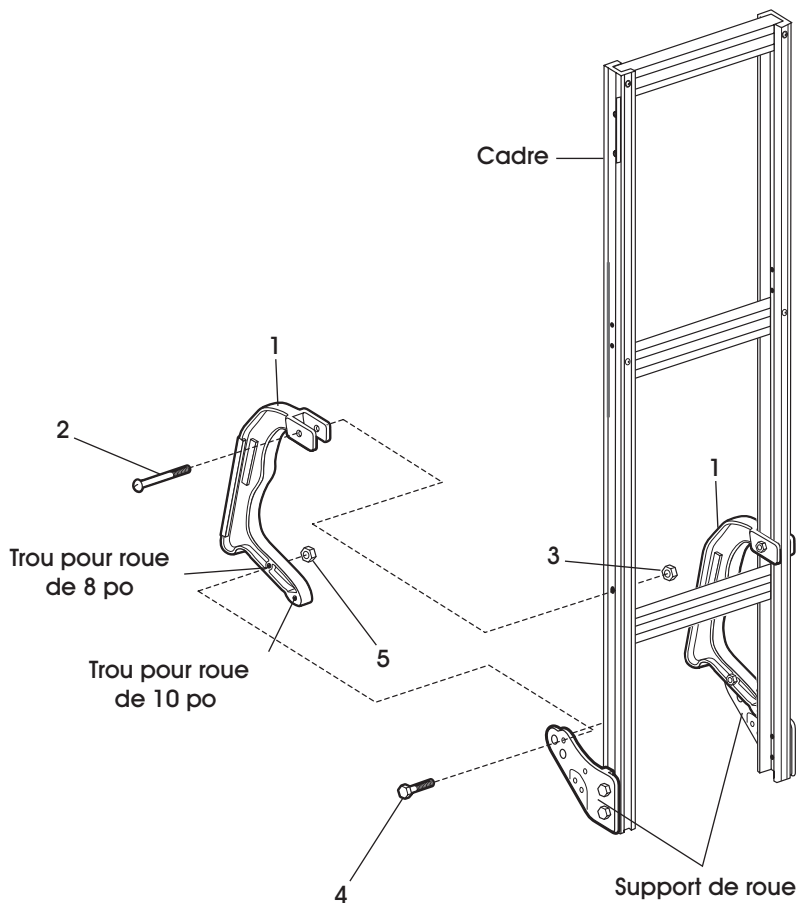

#	QTÉ	DESCRIPTION
1	2	Escaladeur
2	2	Vis à tête cylindrique de 1/4 po-20 x 1 7/8 po
3	2	Écrou autobloquant de 1/4 po
4	2	Boulon à tête hexagonale de 5/16 po-18 x 1 1/4 po
5	2	Écrou autobloquant de 5/16 po

MONTAGE

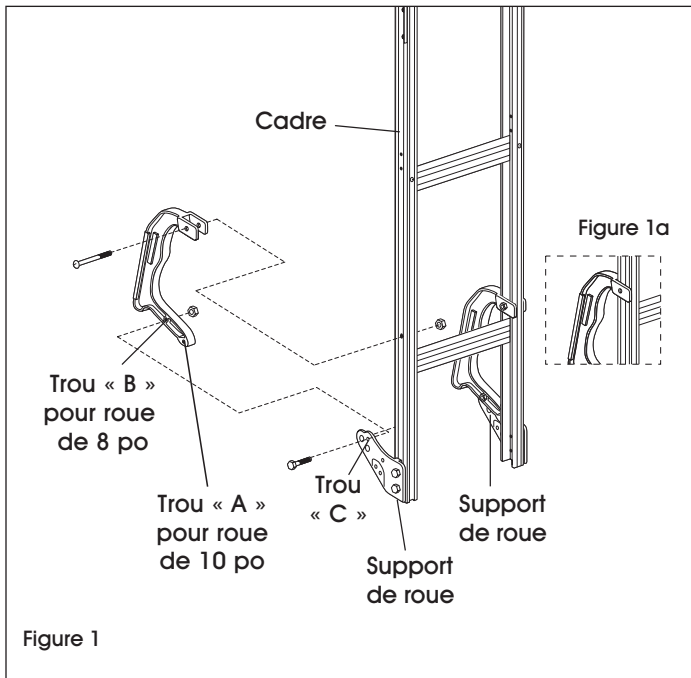

1. Assemblez chaque côté de l'escaladeur (Voir Figure 1)
 - a. Alignez le trou de l'escaladeur (trou marqué « A » pour les roues de 10 po ou « B » pour les roues de 8 po) avec le trou du support de roue marqué « C ».
 - b. Insérez un boulon à tête hexagonale de 5/16 po-18 x 1 1/4 po par l'extérieur du support de roue jusqu'à dans l'escaladeur. Fixez avec un écrou autobloquant de 5/16 po, mais NE serrez PAS.
 - c. Poussez l'escaladeur contre le cadre du diable de manutention jusqu'à ce que l'extrémité ouverte de l'escaladeur s'installe sur le cadre. (Voir Figure 1a)

Insérez une vis à tête cylindrique bombée de 1/4 po-20 x 1 7/8 po par le côté de l'escaladeur jusqu'à dans le cadre. Utilisez un marteau pour percer le cadre à l'aide d'une vis à tête cylindrique de 1/4 po-20 x 1 7/8 po. Sécurisez avec un écrou autobloquant de 1/4 po.

- d. Serrez tous les écrous autobloquants.