

ULINE H-1814
HEAT TREATED
WOOD PALLET

1-800-295-5510
 uline.com

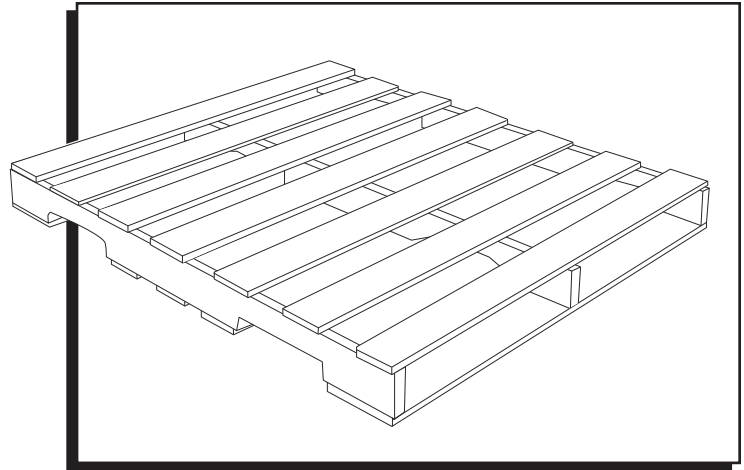

PRODUCT DIMENSIONS

TOP VIEW

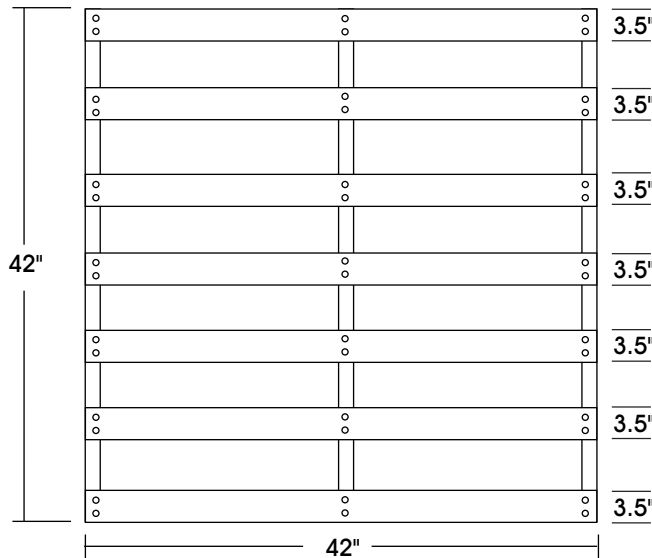

SIDE VIEW

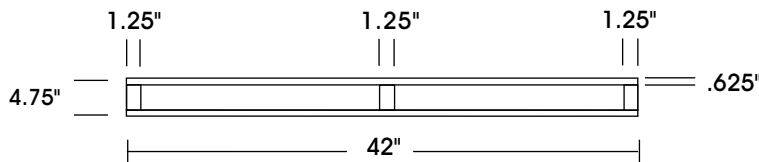
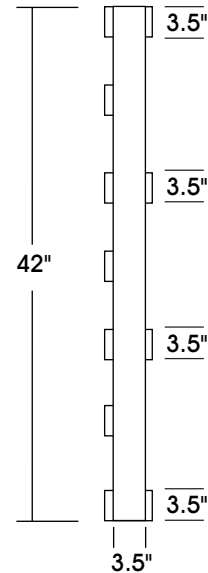

END VIEW

SPECIFICATIONS

MODEL #	DIMENSIONS		HEIGHT		TRAILER QUANTITY		WEIGHT CAPACITY		WEIGHT
	L	W	FORK	OVERALL	48'	53'	FLOOR	FORK	
H-1814	42"	42"	3.5"	4.75"	520	600	5,851 lbs.	4,394 lbs.	40 lbs.

ULINE H-1814

01-800-295-5510

uline.mx

**TARIMA DE
MADERA TRATADA
CON CALOR**

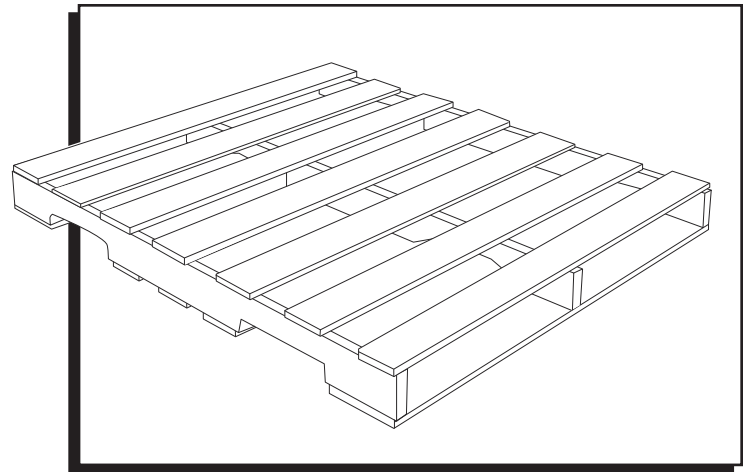

DIMENSIONES DEL PRODUCTO

VISTA SUPERIOR

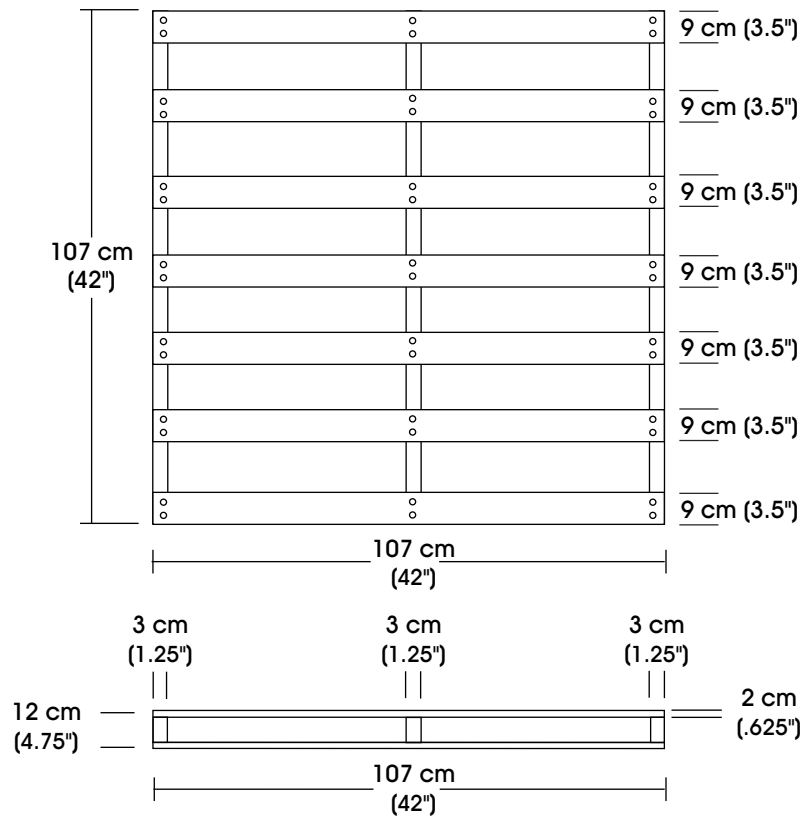

VISTA DEL EXTREMO

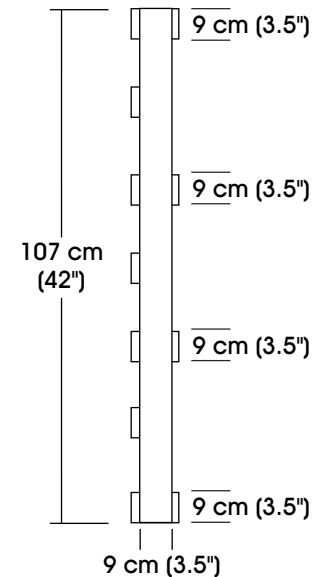

VISTA LATERAL

ESPECIFICACIONES

MODELO NO.	DIMENSIONES		ALTO		CANTIDAD POR TRÁILER		CAPACIDAD DE PESO		PESO
	LARGO	ANCHO	HORQUILLA	GENERAL	14.6 m (48')	16.15 m (53')	PISO	HORQUILLA	
H-1814	107 cm (42")	107 cm (42")	9 cm (3.5")	12 cm (4.75")	520	600	2,653 kg (5,851 lbs.)	1,993 kg (4,394 lbs.)	18 kg (40 lbs.)

ULINE H-1814
PALETTE DE BOIS
TRAITÉ À LA
CHALEUR

1-800-295-5510
 uline.ca

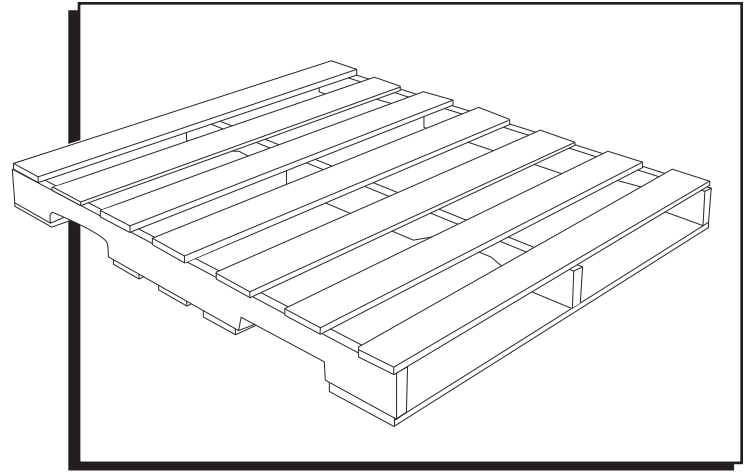

DIMENSIONS DU PRODUIT

VUE DE DESSUS

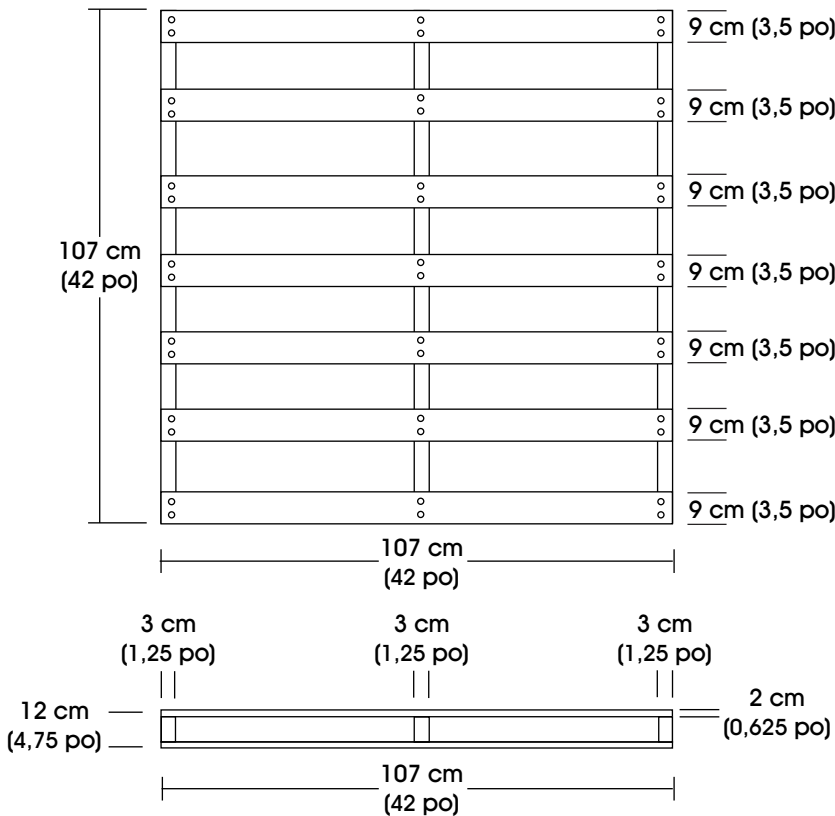

VUE DE L'EXTRÉMITÉ

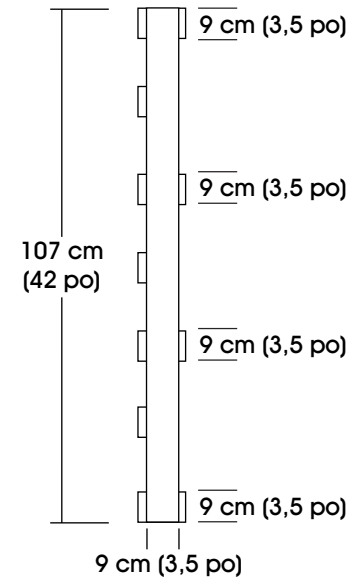

VUE LATÉRALE

SPÉCIFICATIONS

N° DE MODÈLE	DIMENSIONS		HAUTEUR		QUANTITÉ PAR REMORQUE		CAPACITÉ PONDÉRALE		POIDS
	LONG.	LARG.	FOURCHE	TOTALE	14,6 m (48 pi)	16,15 m (53 pi)	PLANCHER	FOURCHE	
H-1814	107 cm (42 po)	107 cm (42 po)	9 cm (3,5 po)	12 cm (4,75 po)	520	600	2 653 kg (5 851 lb)	1 993 kg (4 394 lb)	18 kg (40 lb)