

ULINE H-3575, H-3576
H-3577, H-3578
PLASTIC DUNNAGE RACKS

1-800-295-5510
uline.com

ASSEMBLY INSTRUCTIONS

Step 1 – Lay panel face down and insert 12" posts as shown.
(Make sure posts are pushed all the way down.)

Step 2 – Return rack to upright position.

 **Note: Oil all sockets before assembly.**

**COMPONENTS
H-3575**



Panel: (1) 36 x 24"
Posts: (5) 12"

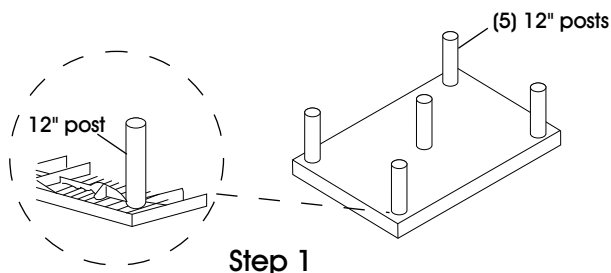

Step 1

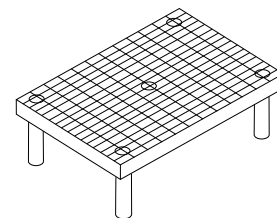

Step 2

**COMPONENTS
H-3576**

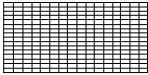

Panel: (1) 48 x 24"
Posts: (9) 12"

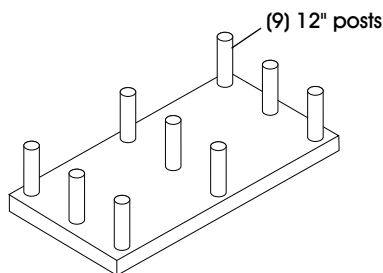

Step 1

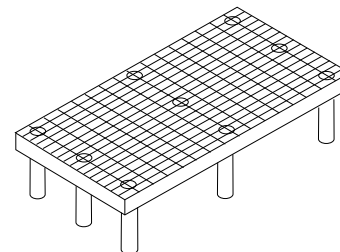

Step 2

**COMPONENTS
H-3577**

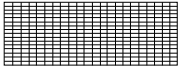

Panel: (1) 66 x 24"
Posts: (8) 12"

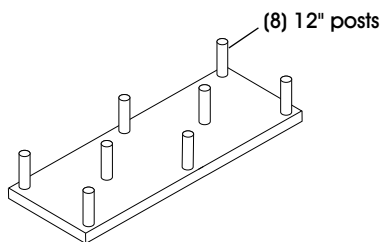

Step 1

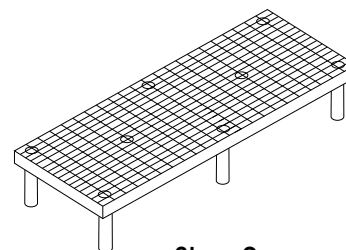

Step 2

**COMPONENTS
H-3578**

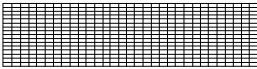

Panel: (1) 96 x 24"
Posts: (11) 12"

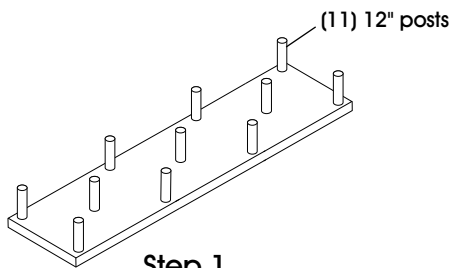

Step 1

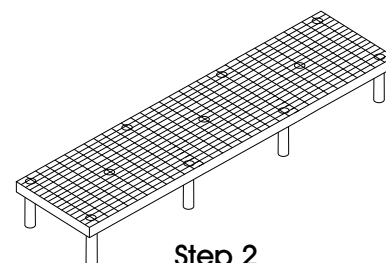

Step 2



H-3575, H-3576
H-3577, H-3578

RACKS DE PLÁSTICO PARA CARGA

01-800-295-5510
uline.mx

INSTRUCCIONES DE ENSAMBLE

Paso 1 – Coloque el panel boca abajo e inserte los postes de 30.5 cm (12") como se muestra. (Asegúrese de que los postes están insertados hasta el fondo).

Paso 2 – Vuelva a colocar el rack en posición vertical.

 **Nota:** Lubrique todas las ranuras antes del ensamble.

COMPONENTES:
H-3575



Panneau : (1) 91.4 x 61 cm
(36 x 24")
Montants : (5) 30.5 cm (12")

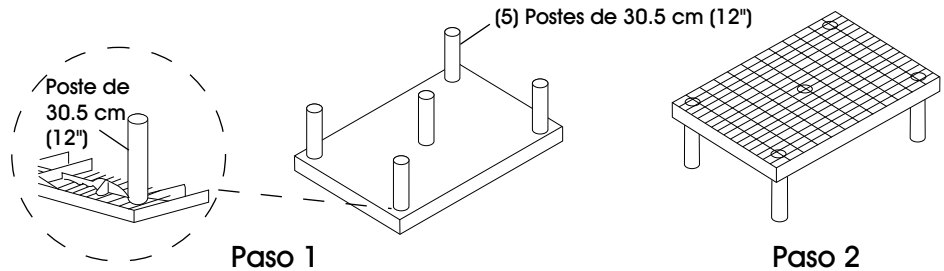

COMPONENTES:
H-3576

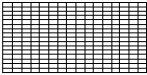

Panneau : (1) 122 x 61 cm
(48 x 24")
Montants : (9) 30.5 cm (12")

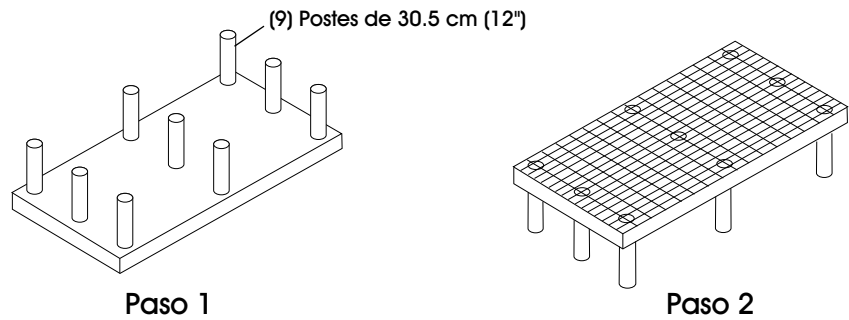

COMPONENTES:
H-3577

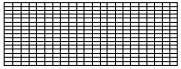

Panneau : (1) 167.6 x 61 cm
(66 x 24")
Montants : (8) 30.5 cm (12")

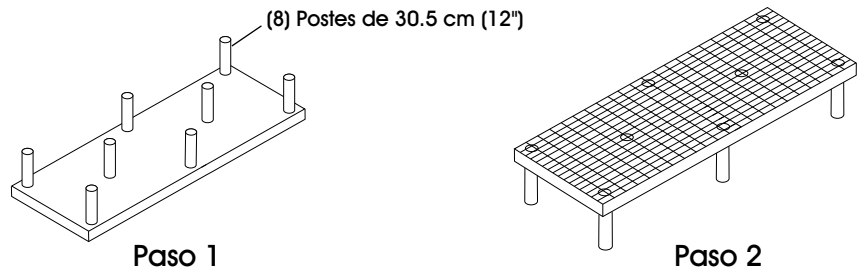

COMPONENTES:
H-3578

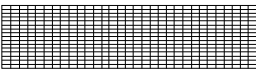

Panneau : (1) 243.8 x 61 cm
(96 x 24")
Montants : (11) 30.5 cm (12")

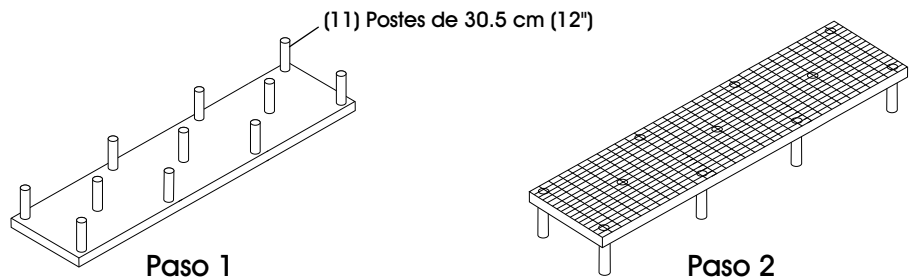



H-3575, H-3576
H-3577, H-3578

1-800-295-5510
uline.ca

SUPPORTS DE FARDAGE EN PLASTIQUE

INSTRUCTIONS D'ASSEMBLAGE

Étape 1 – Déposez le panneau face contre terre et insérez les montants de 30,5 cm (12 po) comme indiqué. (Assurez-vous que les montants sont complètement enfoncés.)

Étape 2 – Retournez le support en position debout.

 **REMARQUE :** Huilez toutes les emboîtures avant l'assemblage.

**COMPOSANTS
H-3575**



Panneau : (1) 91,4 x 61 cm
(36 x 24 po)
Montants : (5) 30,5 cm (12 po)

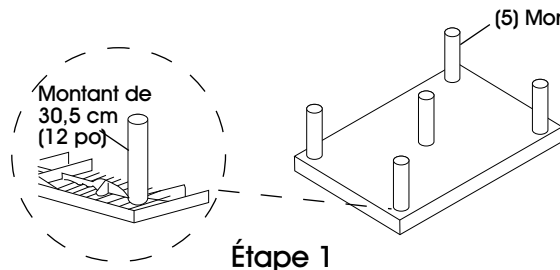

Étape 1

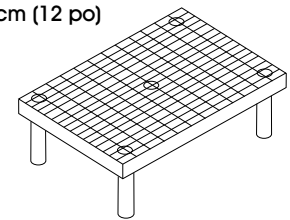

Étape 2

**COMPOSANTS
H-3576**

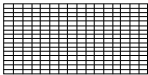

Panneau : (1) 122 x 61 cm
(48 x 24 po)
Montants : (9) 30,5 cm (12 po)

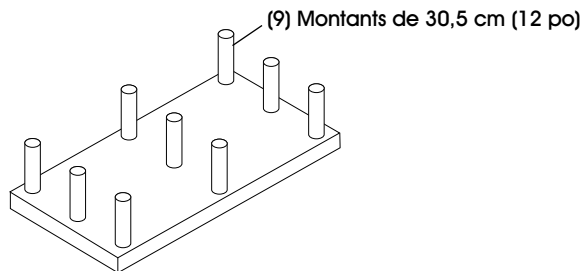

Étape 1

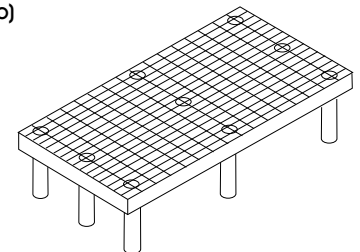

Étape 2

**COMPOSANTS
H-3577**

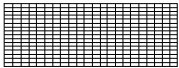

Panneau : (1) 167,6 x 61 cm
(66 x 24 po)
Montants : (8) 30,5 cm (12 po)

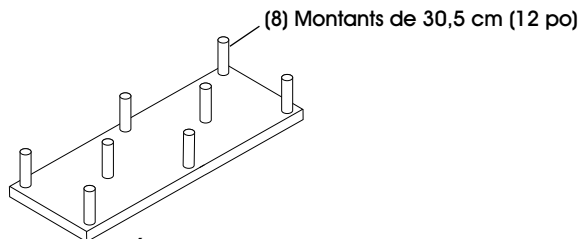

Étape 1

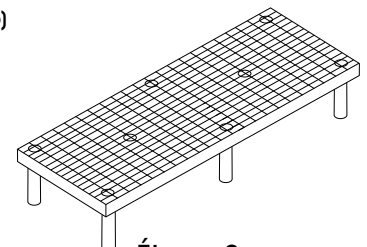

Étape 2

**COMPOSANTS
H-3578**



Panneau : (1) 243,8 x 61 cm
(96 x 24 po)
Montants : (11) 30,5 cm (12 po)

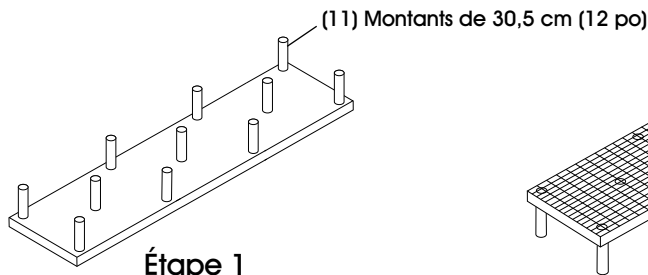

Étape 1

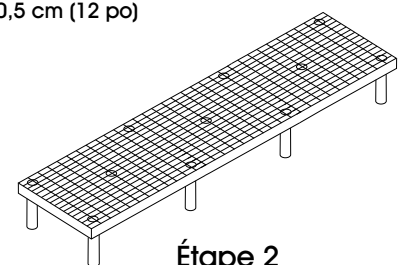

Étape 2