

ULINE H-6471 TIRE HAND TRUCK

1-800-295-5510
uline.com

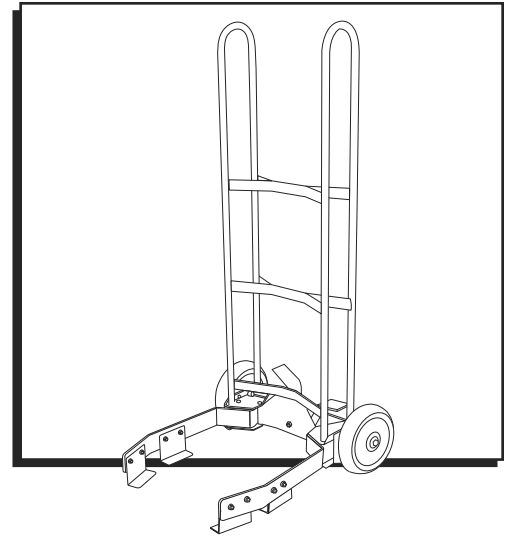

TOOL NEEDED



8 mm Allen Wrench

PARTS

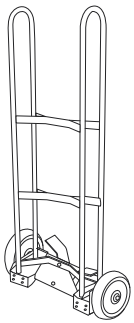

Frame x 1

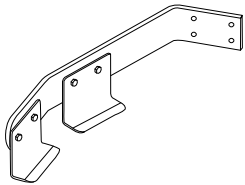

Right Arm x 1

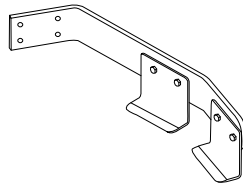

Left Arm x 1

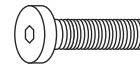

Bolt x 8

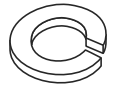

Lock Washer x 8

ASSEMBLY

1. Lay frame on flat, non-marring surface with foot pedal on ground.
2. With clamps facing inward, attach left and right arms to frame using bolts and lock washers. (See Figure 1)
3. Tightly secure all bolts.

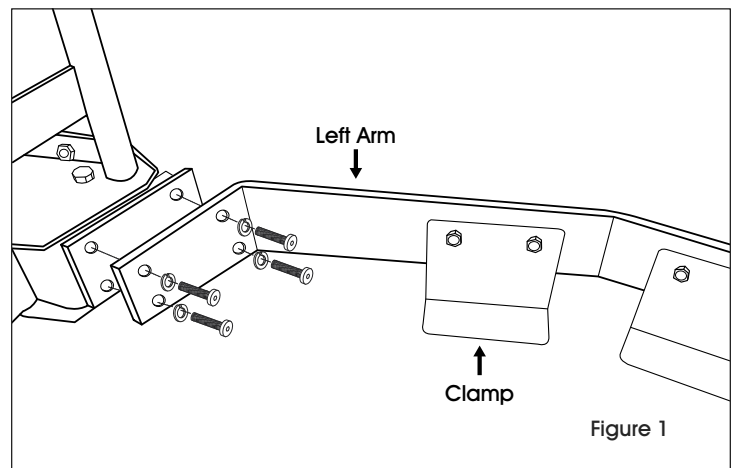
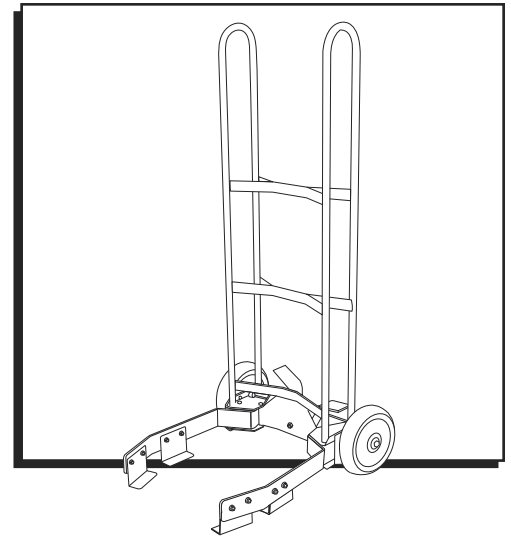

Figure 1

ULINE H-6471 DIABLITO PARA LLANTAS

01-800-295-5510
uline.mx



HERRAMIENTA NECESARIA



Llave Allen de 8 mm

PARTES

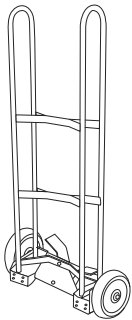

1 Armazón

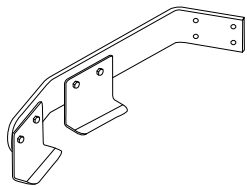

1 Brazo Derecho

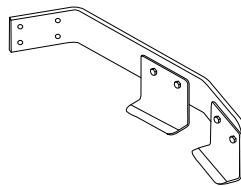

1 Brazo Izquierdo

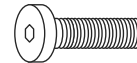

8 Pernos

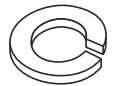

8 Rondanas de Seguridad

ENSAMBLE

1. Recueste el armazón sobre una superficie plana.
2. Con las abrazaderas hacia el interior, fije los brazos izquierdo y derecho al armazón utilizando los pernos y las rondanas de seguridad. (Vea Diagrama 1)
3. Ajuste todos los pernos.

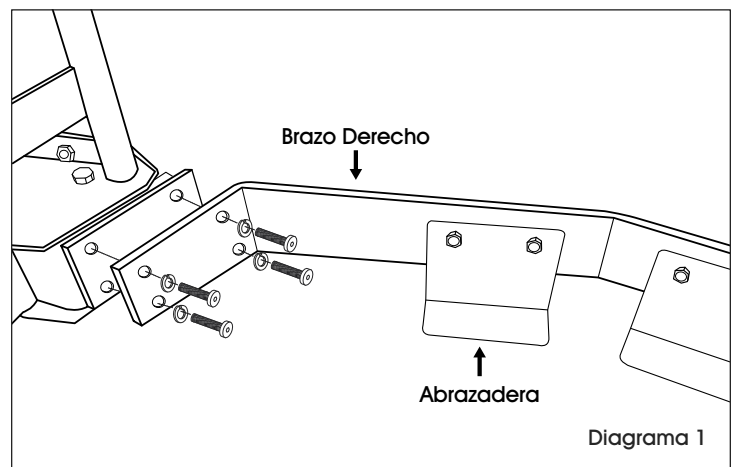

ULINE H-6471

DIABLE DE MANUTENTION POUR PNEU

1-800-295-5510

uline.ca

OUTIL REQUIS



Clé allen de 8 mm

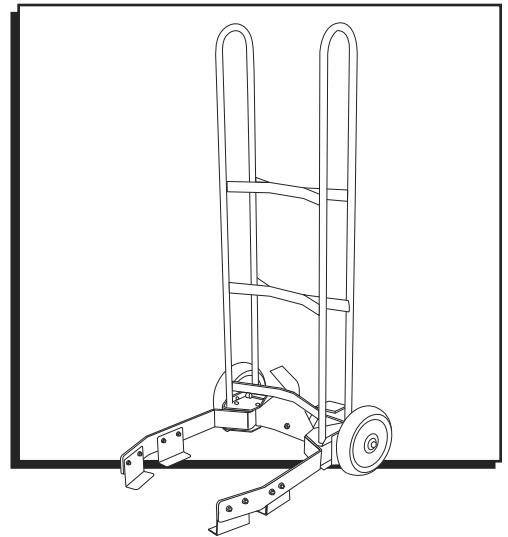

PIÈCES

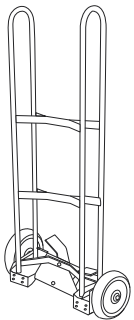

Cadre x 1

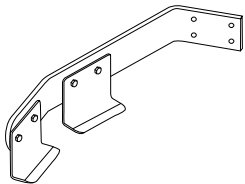

Bras droit x 1

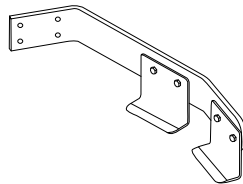

Bras gauche x 1

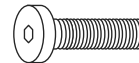

Boulon x 8

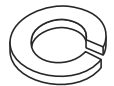

Rondelle de
blocage x 8

MONTAGE

1. Placez le cadre sur une surface plane et non grattante avec la pédale au sol.
2. Avec les pinces orientées vers l'intérieur, attachez les bras gauche et droit au cadre à l'aide des boulons et des rondelles de blocage. (Voir Figure 1)
3. Serrez solidement tous les boulons.

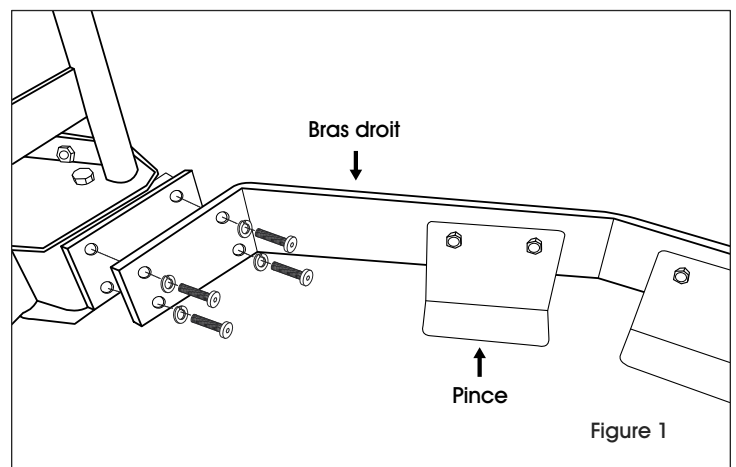

Figure 1